

**NIVONA**

*passion for coffee*

GB User manual



## WELCOME TO THE NIVONA FAMILY!

We are delighted at the confidence you have shown in us by choosing a quality product from NIVONA.

We would like to express our sincere **THANKS**.

To ensure maximum enjoyment of your NIVONA machine, please read through this document carefully and pay attention to the safety instructions before using the machine for the first time.

Please keep this document in a safe place. Then you can use it as a reference or pass it on to any subsequent owner.

We hope you enjoy your NIVONA product and, with it, a good, flavourful cup of coffee.

Best wishes to you from the NIVONA team!



## SYMBOLS USED

The following symbols are used in these instructions:



### CAUTION

This symbol draws your attention to possible dangers.



### NOTE

This symbol draws your attention to special information.



### TIP

This symbol indicates helpful advice on how to use the machine.

## CONTENTS

<b>1. SAFETY INSTRUCTIONS.....</b>	<b>4</b>	<b>7. BASIC SETTINGS.....</b>	<b>17</b>
1.1. Correct use.....	4	7.1. General settings.....	17
1.2. General instructions for the user.....	4	7.2. Set grind fineness.....	19
1.3. Limits to the range of users.....	5	7.3. Aroma Balance System.....	19
<b>2. CONTROL ELEMENTS.....</b>	<b>6</b>	7.4. NIVONA app.....	20
<b>3. OPERATION OF THE MACHINE.....</b>	<b>7</b>	<b>8. CLEANING &amp; MAINTENANCE.....</b>	<b>20</b>
3.1. Function switches.....	7	8.1. Rinse frother.....	21
3.2. Operation with the rotary dial.....	7	8.2. Clean frother.....	22
3.3. Operation with the touchscreen.....	8	8.3. Rinse system.....	23
3.4. Functions of the buttons.....	8	8.4. Clean system.....	23
<b>4. INITIAL STARTUP.....</b>	<b>9</b>	8.5. Descale system.....	24
4.1. Preparation.....	9	8.6. Remove & clean brewing unit.....	25
4.2. Initial Start menu.....	9	8.7. Clean regularly by hand.....	26
<b>5. MENU NAVIGATION.....</b>	<b>11</b>	8.8. Disassemble and clean frother.....	27
<b>6. PREPARE SPECIALTY COFFEES.....</b>	<b>12</b>	8.9. Change filter.....	27
6.1. Draw specialty coffee.....	12	8.10. Status of maintenance.....	28
6.2. 2-cup function.....	13	<b>9. SOLVING PROBLEMS YOURSELF.....</b>	<b>29</b>
6.3. COFFEE quantity function (can symbol).....	13	<b>10. ACCESSORIES &amp; COFFEE ASSORTMENT.....</b>	<b>32</b>
6.4. Cappuccino Connaisseur.....	14	<b>11. CUSTOMER SERVICE &amp; WARRANTY.....</b>	<b>32</b>
6.5. Flavour profiles.....	14	<b>12. PACKAGING &amp; DISPOSAL.....</b>	<b>32</b>
6.6. MY COFFEE (for individual specialty coffees).....	14	<b>13. TECHNICAL DATA.....</b>	<b>33</b>
6.7. Permanent recipe settings.....	15		
6.8. Prepare ground coffee.....	16		

## 1. SAFETY INSTRUCTIONS

### CAUTION

Repairs to electrical appliances must be carried out only by specialised technicians! Improper repairs can expose the user to considerable dangers! If the machine is used other than for its intended purpose or is operated or maintained improperly, we cannot accept liability for any resulting damage!

### CAUTION

Actuating the on/off switch during the brewing process can damage the machine! Switch the machine off only when it is idle!

### CAUTION

Danger of burns! Hot water might spray out of the outlet at first when steam or hot water is drawn. Touch the outlet only when cold.

### 1.1. Correct use

- The machine is intended for use in the home and similar applications such as kitchens for personnel, shops, offices and other commercial premises, agricultural estates, by customers in hotels, motels and other residential establishments and in bed and breakfasts (see warranty terms attached). Otherwise the warranty will be void.

### 1.2. General instructions for the user

- Set the machine on a dry, level and stable surface, and use it only indoors. Never place this machine on a hot surface, near other appliances which become very hot when in use (e.g. stove, deep fryer), or near open flames.
- The machine must not be used in cupboards or other closed pieces of furniture.
- The mains supply voltage must always match the working voltage of the machine. Please refer to the type plate on the machine.
- The machine must not be used at altitudes over 2000 m above sea level.
- Do not operate the machine if the mains supply cable or the casing is damaged. Never let the mains supply cable touch hot parts.
- If the mains supply cable of the machine is damaged, it must be replaced by the manufacturer, its customer service representative, or a similarly qualified technician to avoid hazards.
- Never immerse the machine in water.
- Always keep the mains supply plug dry and keep it away from moisture.
- Do not pull on the mains supply cable to disconnect the plug from the mains socket.

- If a fault occurs, disconnect the mains plug immediately (never by pulling on the mains supply cable or the machine itself).
- Before carrying out maintenance or cleaning, check that the machine is switched off and that the mains plug is disconnected.
- No liability for damage is accepted in case of incorrect operation, improper use, or incorrect repairs. The warranty is void in these cases.
- Always follow the instructions for cleaning and descaling! Failure to comply voids the warranty.
- Never clean the machine or individual parts in the dishwasher. Failure to comply voids the warranty.
- Do not leave the machine switched on unnecessarily.
- If you will be away for several days, always unplug the mains supply cable.
- Please use the integrated coffee grinder only to grind roasted and untreated coffee beans, not for other food items! Always make sure that there are no foreign objects mixed in with the coffee beans, which voids the warranty.
- If repair of the machine is required (including replacement of the mains cable!), please first contact the NIVONA service telephone or the dealer from which the machine was purchased, and, after consultation

with us and observing the section “How to make your machine ready for shipment” in Chapter 11 of this document, send it to **NIVONA Central Customer Service, Südwestpark 49, D-90449 Nuremberg, Germany.**

### 1.3. Limits to the range of users

- This machine can be used by children 8 and older and by persons with physical, sensory, or mental impairments or who are lacking in experience and knowledge, provided they are acting under supervision or have been instructed on how to use the machine safely and are aware of the possible dangers. Children must not play with the machine. Cleaning and maintenance of this machine must not be carried out by children unless they are age 8 or over and are acting under supervision. The machine and its connection line must be kept away from children younger than 8.

# 2.

## 2. CONTROL ELEMENTS

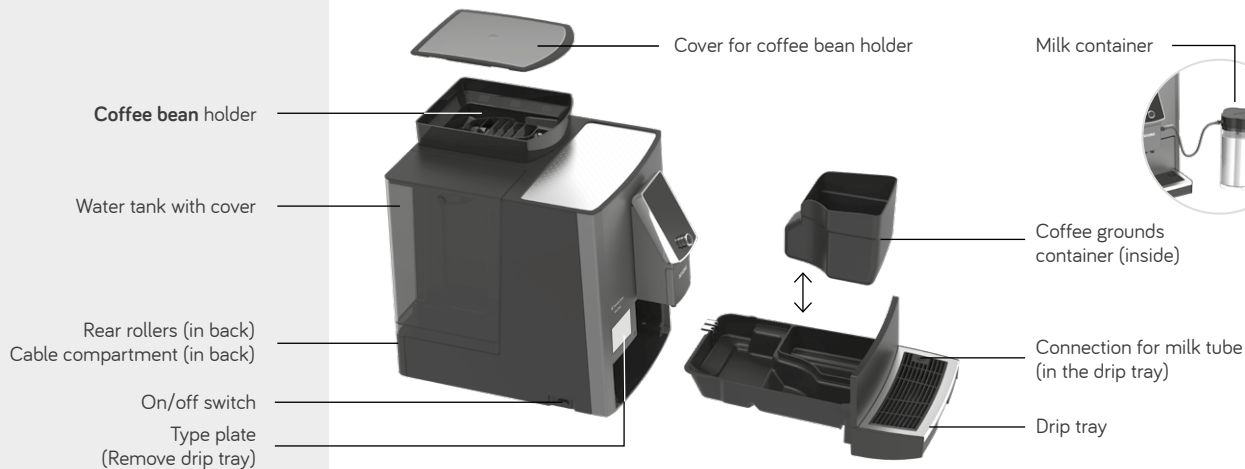

### WELCOME PACK (included with machine)

- 2 CLARIS fresh water filters
- Operating instructions
- Warranty terms
- Measuring spoon
- 2 cleaning tablets
- Test strips (for measuring water hardness)
- 2 connection tubes for milk:



With the **single milk tube** only **manual rinsing** of the frother is possible.



With the **double milk tube** **automatic rinsing** of the frother is carried out after a pre-set time (**easyclean\***).

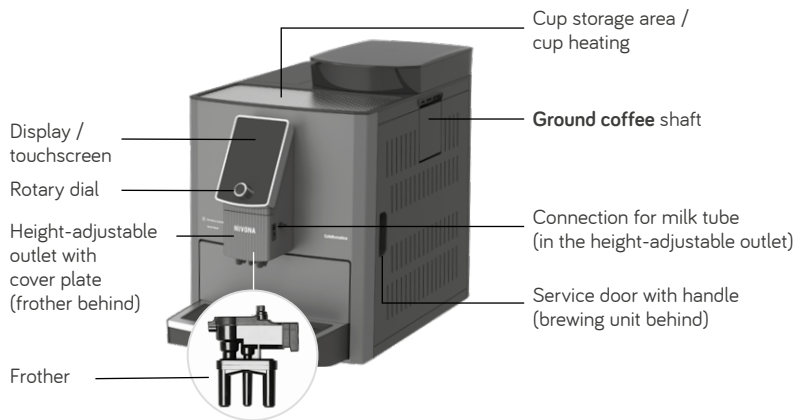

## 3. OPERATION OF THE MACHINE

### 3.1. Function switches

The NIVONA machine can be operated with the following switches:



**Rotary dial**

navigate / select / change /  
confirm by turning and pressing



**Touchscreen**

navigate / select / change /  
confirm by touching

### 3.2. Operation with the rotary dial

#### Turning the rotary dial

To change between the three main menus **SPECIALTY COFFEES**, **SETTINGS** and **MAINTENANCE**, to select / navigate within the main menus and to change the setting options in the submenus and **Recipe menu**.

#### Pressing the rotary dial

To start / confirm the currently marked function or the changed setting option.

In the submenus and in the **Recipe menu**, the first press selects the setting parameters and the next press confirms the change.

Pressing the *rotary dial* once when the beverage is drawn cancels the procedure. If the draw is cancelled while the parameters are still flashing, the *rotary dial* must be pressed 2x.









\* The Recipe menu only appears before each draw of a specialty coffee if DIRECT DISPENSING is disabled (SETTINGS - COMFORT SETTINGS menu).

### 3.3. Operation with the touchscreen

Using the touchscreen, the menu and function selection can be made directly by touching the symbols and buttons.

### 3.4. Functions of the buttons

The buttons can be selected either by touching (directly) or with the *rotary dial* (by turning and pressing). To change a setting option in the **SPECIALTY COFFEES** and **SETTINGS** menus, turn the *rotary dial*. The arrow symbols can only be operated by touching.

	start		back   leave menu
	confirm   save		select option   enable
	confirm   to next step		navigate   select by touching
	cancel		confirm a message / instruction
	Instruction for a manual action on the machine	The currently selected symbol / function is highlighted; the symbol description is displayed in the SPECIALTY COFFEES menu.	



## 4. INITIAL STARTUP

### 4.1. Preparation

- Remove the machine and other supplied parts from the packaging
- Place the machine on a level, dry work surface (ventilation slots must not be covered)
- Connect the mains supply cable to a power socket which has been correctly installed (any unnecessary length of cable remains inside the cable compartment)
- Switch on the machine

If the machine is switched on **after the initial startup**, it first heats up. If the automatic switch-on rinse is enabled, the display shows **RINSING SYSTEM** and the rinse procedure starts automatically. If the automatic switch-on rinse is disabled, the display shows **PLEASE RINSE** and the rinse procedure must be started.

### 4.2. Initial Start menu

The instructions on the display lead you through the Initial Start menu conveniently and step-by-step.

#### Set language

- Select the language and confirm

#### Set filter

- Select the filter setting

#### NOTE

Details on **Operation of the machine** are contained in Chapter 3, starting at page 7.



Filter YES

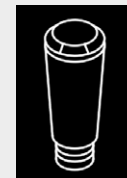

Filter NO



Example: Water hardness display DEGREE 3

Test strips	Degree of hardness	Water hardness display
≤ 1 red point	1 - 7°	DEGREE 1
2 red points	8 - 14°	DEGREE 2
3 red points	15 - 21°	DEGREE 3 (factory setting)
≥ 4 red points	> 21°	DEGREE 4



FILL WATER TANK



FILL COFFEE BEANS

### Operation with filter

- Set the menu to **INSERT FILTER?** Set **YES** and confirm with **NEXT**

#### NOTE

If used with a filter, the machine does not need to be descaled as often.

### Operation without filter

(factory setting)

- Set the menu to **INSERT FILTER?** Set **NO** and confirm with **NEXT**

When using the machine without a filter, the water hardness must be entered in the next step.

### Set water hardness\*

- Immerse supplied test strip briefly in water, shake it off and read the test result after about 1 minute
- In the menu, select the water hardness read from the test strip and confirm with **NEXT**.

### Fill water tank (> 0.7l)

- **Remove** the water tank and fill it with fresh, cold water without carbonation (no mineral water), reinsert the tank.

Do not fill any carbonated liquids or any other liquids, or the warranty is void!

### Fill coffee bean holder

- Fill the coffee bean holder with untreated, roasted coffee beans without foreign objects or dirt and without sugar, then close the flavour protection cover well

\* For operation without filter

**Insert filter\***

- Using the mounting aid at the end of the measuring spoon, screw the filter into the water tank
- Place a large container (> 0.5 l) under the outlet and confirm with **NEXT**

**Rinse filter\*, fill / rinse system**

A message / instruction is shown on the display when the system has to be filled

- Place a large container (> 0.5 l) under the outlet
- Wait until no more water comes out of the outlet, then empty the container
- Confirm the message / instruction

All settings that were determined during initial startup can be changed at any time in the **SETTINGS** menu.

**5. MENU NAVIGATION**

In the NIVONA machine, you can select the main menus **SETTINGS**, **SPECIALTY COFFEES**, and **MAINTENANCE**. All available functions of the machine can be carried out within these main menus.

Detailed information on navigation within and between the main menus is found in Chapter 3 starting at page 7.

\* For operation with filter

**CAUTION**

Insert the filter **straight** and do not overturn!



Insert the filter



RINSING  
FILTER



FILLING  
SYSTEM



RINSING  
SYSTEM



SETTINGS



SPECIALTY  
COFFEES



MAINTENANCE

**i NOTE**

At first preparation, the grinding chamber is still empty. After the first grinding, it is possible that **FILL BEANS** is displayed and the machine does not make coffee.

- Follow the instructions on the display and press the *rotary dial* again for an additional draw; the process is then repeated

**⚠ CAUTION**

Before switching off the machine, the frother must be rinsed **also when using the double milk tube** (if a message / instruction appears on the display) and the **connection (valve)** of the double milk tube **must be rinsed** under cold, clean water (see Chapter 8.7. on page 26).

- With the *rotary dial* / by touching select and confirm the message / instruction on the display



Double milk tube



Single milk tube

– connected to the milk container –

**6. PREPARE SPECIALTY COFFEES****6.1. Draw specialty coffee**

- Select the desired specialty coffee in the **SPECIALTY COFFEES** menu
- For specialty coffees with milk, connect the milk-filled container (milk container, milk cooler, Tetra Pack, etc.) to one end of the milk tube (in case of a double milk tube to the valve). Connect the other end to the height-adjustable outlet
- When direct dispensing is enabled (see Chapter 7.1. on page 17), short pressing / touching the desired specialty coffee starts dispensing immediately
- When direct dispensing is disabled (see Chapter 7.1. on page 17), short pressing / touching the desired specialty coffee takes you to the recipe menu for the stored beverage, with the option of changing some of the stored parameters for the next dispensing
- Confirmation in the recipe menu of the specialty coffee starts the beverage dispensing

After completing the preparation of a specialty coffee with milk, the display shows the message / instruction to rinse the frother.

If the **single milk tube** is used, the frother should be rinsed as soon as possible, but at the latest before switching off the machine.

- Reconnect the tube to the drip tray, select and confirm the message / instruction on the display with the *rotary dial* / by touching and follow the instructions on the display until the end of the program



RINSE VALVE  
UNDER COLD  
WATER

If the **double milk tube** is used, the frother does not need to be rinsed immediately, because the **easyclean<sup>+</sup>** rinsing program rinses it automatically after the set time (see Chapter 7.1. on page 17). It is not necessary to remove the tube end from the connected milk source.

Even **during** a started coffee dispensing, the parameters coffee strength, quantity, aroma and 2-cup function can still be changed by selecting and turning the *rotary dial* **as long as they are flashing**.

Beverage dispensing can be cancelled either with **CANCEL** or by pressing the *rotary dial*. If dispensing is cancelled with the *rotary dial* while the parameters are still flashing, the *rotary dial* must be pressed several times.

## 6.2. 2-cup function\*

- To dispense two cups of the same beverage directly one after the other at the press of a button / by touching, the cup symbol must be changed during dispensing and a second cup must be placed under the outlet

## 6.3. COFFEE quantity function (can symbol)

- To dispense up to 8 cups (max. 1.9 l) of the specialty coffee **COFFEE** one after the other, place a suitably large container under the outlet and change the cup symbol to the desired quantity. When **direct dispensing is enabled** (see Chapter 7.1. on page 17), the cup symbol must be changed **during dispensing**. If **direct dispensing is disabled**, the cup symbol is changed **in the recipe menu before dispensing**.
- If the quantity of coffee beans or water falls below the minimum quantity during dispensing, dispensing can either be continued or cancelled after refilling.

\* Not for CAFFÈ AMERICANO, HOT WATER

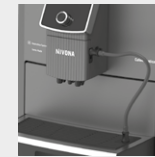

Single milk tube –  
connected to drip tray



### CAUTION

Before removing the double milk tube, the frother must be rinsed (if a message / instruction appears on the display).



Confirm the message / instruction on the display.



1 cup



2 cups



Can



QUICK



DYNAMIC



CONSTANT



INTENSE



MY COFFEE

## 6.4. Cappuccino Connoisseur

- By changing the **PREPARATION**, CAPPUCCINO or CAFFÈ LATTE lovers can determine in **BEVERAGE RECIPES** whether milk (milk → coffee), coffee (coffee → milk) or both at the same time (coffee + milk) is added to the cup first

## 6.5. Flavour profiles

- Changing the flavour profile (DYNAMIC | CONSTANT | INTENSE) changes the brewing process and extraction from the beans and thus the taste of the coffee (see also Chapter 7.3 Aroma Balance System on page 19).
- The QUICK flavour profile makes it possible to dispense a specialty coffee **more quickly** than the other three flavour profiles

## 6.6. My Coffee (for individual specialty coffees)

Up to 20 different beverages can be individually set, named, and stored with the NIVONA machine.

- To do this, in the **SETTINGS** menu select the menu option **BEVERAGE RECIPES** and edit, add or delete beverages under **MY COFFEE**

### Add a beverage:

Select basic recipe, assign name, go one step further, select symbol, set individual recipe, save and exit the menu

## 6.7. Permanent recipe settings

The following parameters for the individual specialty coffees can be permanently set in the **SETTINGS** menu under the item **BEVERAGE RECIPES**:

<b>STRENGTH</b>	<b>FLAVOUR*</b> (DYNAMIC, CONSTANT, INTENSE)	<b>PREPARATION**</b> (Cappuccino Connaisseur)
<b>QUANTITY</b> (coffee / milk foam / water / milk, depending on the specialty coffee)	<b>TEMPERATURE***</b> (NORMAL, HIGH, HOT, MAXIMUM)	

- Pressing the *rotary dial* / touching **OK** saves the changed parameters
- Press **EXIT** to exit the menu level

\* Only if the **INDIVIDUAL** option is selected in the **AROMA** menu option of the **SETTINGS** menu

\*\* Only for **CAPPUCCINO** or **CAFFÈ LATTE**

\*\*\* Only if the **INDIVIDUAL** option is selected under **TEMPERATURE** in the **SETTINGS** menu; the available temperature options depend on the beverage

### **NOTE**

Detailed information for setting a permanent **TEMPERATURE** and for the general setting of an **FLAVOUR PROFILE** is given in chapter 7.1. General settings on page 17

DE

GB

FR

NL

PL

RU

**CAUTION**

The ground coffee shaft is not a storage container. Therefore, never add more than one portion to the shaft and use only fresh or vacuum-packed ground coffee from coffee beans.

**Water-soluble instant coffee must not be used!**



FILL GROUND  
COFFEE



CLOSE THE  
GROUND COFFEE  
SHAFT LID

**6.8. Prepare ground coffee**

- Open the lid of the ground coffee shaft (top centre on the right-hand side of the machine)
- The display alternately shows **FILL COFFEE POWDER** and **CLOSE GROUND COFFEE SHAFT**
- Add a level measuring spoon of ground coffee
- Close the cover and flap
- The display shows when the ground coffee is ready
- Place a cup in the middle below the coffee outlet
- Select the beverage in the **SPECIALTY COFFEES** menu
- Start preparation

**NOTE**

If you accidentally open the ground coffee shaft – or have not started a beverage draw after adding ground coffee – the machine is automatically rinsed about one minute after the cover is closed again and is then ready for use again.





SETTINGS

## 7. BASIC SETTINGS

### 7.1. General settings

All parameters displayed in the **SETTINGS** menu can be changed using the *rotary dial* / by touching.

<p><b>BEVERAGE RECIPES</b></p> <ul style="list-style-type: none"> <li>- Permanent recipe setting of the individual specialty coffee</li> <li>- LIVE PROGRAMMING within the individual beverages, i.e. changing and saving the recipe setting during dispensing</li> </ul> <p>(Select LIVE PROGRAMMING within the beverage recipe and follow the instructions on the display)</p>	<p><b>FILTER</b></p> <p>Set operation with / without filter</p>	<p><b>WATER HARDNESS</b></p> <ul style="list-style-type: none"> <li>- Set the water hardness</li> </ul> <p>(only displayed during operation without filter)</p>
<p><b>FLAVOUR</b></p> <ul style="list-style-type: none"> <li>- Setting the aroma profile for all beverages in the <b>SPECIALTY COFFEE</b> menu (CONSTANT, DYNAMIC, INTENSE, QUICK, INDIVIDUAL)</li> </ul> <p>With the setting <b>INDIVIDUAL</b>, different aroma profiles can be defined for the different specialty coffees</p>	<p><b>TEMPERATURE</b></p> <ul style="list-style-type: none"> <li>- Setting the temperatures for <b>COFFEE</b>, <b>MILK</b>, <b>MILK FOAM</b> and <b>HOT WATER</b> for all beverages in the <b>Specialty Coffee</b> menu (NORMAL, HIGH, HOT, MAXIMUM, INDIVIDUAL)*</li> </ul> <p>With the setting <b>INDIVIDUAL</b>, different temperatures can be defined for the different specialty coffees</p>	<p><b>LANGUAGE</b></p> <ul style="list-style-type: none"> <li>- Set the language</li> </ul>

\* The available temperature options depend on the beverage

**TIMES**

- Activate / deactivate automatic switch-off time
- Activate / deactivate automatic switch-on time  
(setting of the current time and the switch-on time)
- Set time of day\*  
(only appears when the switch-on time is activated)

**COMFORT SETTINGS**

- Activate / deactivate cup heating
- Activate / deactivate display lock / energy saving (ECO) mode\*\*
- Activate / deactivate milk products (specialty coffee with milk)
- Activate / deactivate automatic switch-on rinse
- Set frother rinsing\*\*\*
- Activate / deactivate automatic switch-on rinse
- Activate / deactivate direct dispensing (immediate beverage dispensing with a single press / by touching the SPECIALTY COFFEE menu, without the possibility of making changes in the recipe menu)

**FACTORY SETTING**

- Recipes, settings and Bluetooth can be reset to the factory setting

**STATISTICS**

- Displays the draws per specialist coffee and the performed maintenance functions since initial startup

**BLUETOOTH**

- Connection to smartphone / tablet and control of the machine with the NIVONA app.

\* After disconnection from the power network, the time of day must be reset.

\*\* If the *rotary dial* has not been actuated for a longer period of time, the machine switches automatically into the **ECO mode**. A screen saver appears on the display. Actuate the *rotary dial* to leave the **ECO mode**.

\*\*\* For the **easyclean**\* automatic rinsing program when using the machine with double tube.

## 7.2. Set grind fineness

To change the grind fineness, please:

- Open the service door on the right side of the housing (gently pull the unlocking device inside the handle upward, then carefully remove the service door from the housing)
- Place cup under the height-adjustable outlet
- Select and start ESPRESSO in the **SPECIALTY COFFEE** menu
- While the grinder grinds, change the grind fineness by moving the regulator (above right) (left = finer, right = coarser)
- Close the service door again (guide pins on the rear of the service door into the recesses, then press the service door until it locks in place)

## 7.3. Aroma Balance System

The NIVONA machine is equipped with the **Aroma Balance System**, which brings out the best of the bean for every taste. The three flavour profiles DYNAMIC, CONSTANT and INTENSE create a different taste with the same bean, same coffee strength, and same water amount.

The fourth flavour profile, QUICK, enables a specialty coffee to be dispensed more quickly than with the other three flavour profiles while maintaining a balanced aroma.



QUICK



DYNAMIC



CONSTANT



INTENSE



Open / close the service door

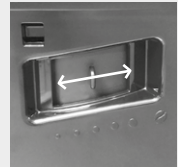

Set grind fineness



### CAUTION

**The grind fineness may only be set when the grinder is running!**

The grinder can be adjusted to adapt to the roast of the coffee beans. We recommend always leaving the grinder at a medium setting.



### NOTE

When changing the grind fineness, we recommend:

- a finer setting for light roasts (regulator further to the left),
- a coarser setting for dark roasts (regulator further to the right).

**NOTE**

The NIVONA machine supports only **one active** Bluetooth connection with a mobile device.

**7.4. NIVONA app**

The NIVONA machine can be controlled and operated through the NIVONA app, as it is equipped with a Bluetooth interface.

- Download the NIVONA app from the Google Play Store (Android) or from the Apple App Store (iOS) onto your mobile device
- In the **SETTINGS** menu, select the **BLUETOOTH** menu option and activate Bluetooth with **CONNECT** on the NIVONA machine
- Activate Bluetooth on your mobile device and from there connect to the NIVONA machine through the NIVONA app

Now the NIVONA machine can be operated / controlled through the app.

**8. CLEANING & MAINTENANCE**

All cleaning and maintenance programs can generally be selected and started in the **MAINTENANCE** menu.

- Select **MAINTENANCE** menu
- Select the cleaning or maintenance program and start it with the *rotary dial* / by touching

The machine starts the corresponding cleaning or maintenance process and displays instructions for additional actions if required.

- Follow the instructions on the display up to the end of the program and confirm each time with the *rotary dial* / by touching



MAINTENANCE

When a message / instruction for cleaning or maintenance activities appears on the display:

- Select and confirm the instruction with the *rotary dial* / by touching

The machine starts the corresponding cleaning or maintenance process and displays instructions for additional actions.

- Follow the instructions on the display up to the end of the program and confirm each time with the *rotary dial* / by touching

### 8.1. Rinse frother

After completing the preparation of a specialty coffee with milk, the display shows the message / instruction to rinse the frother.

If the **single milk tube** is used, the frother should be rinsed as soon as possible, but at the latest before switching off the machine. Proceed as follows:

- Select and confirm the instruction with the *rotary dial* / by touching or
- In the **Maintenance** menu, select the menu option **RINSE FROTHER**
- Connect the supplied tube with one end to the height-adjustable outlet and put the other end in the drip tray, and confirm with the *rotary dial* / by touching
- Put a sufficiently large container ( $\geq 0.5$  l) under the height-adjustable outlet and confirm with the *rotary dial* / by touching

The machine starts the rinse process. As soon as the rinse cycle is ended, the machine heats up and is then ready for operation again.



#### CAUTION

The running program must not be interrupted!

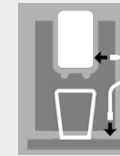

Connect tube



FROTHER  
RINSING



Connected milk container



#### CAUTION

The running program must not be interrupted!

Both the single milk tube and the double milk tube can be used for the cleaning program.



#### CAUTION

If the double milk hose is used, it should be used for cleaning, as the valve must be cleaned regularly. **After cleaning, the valve must always be rinsed with cold, clear water** (see Chapter 8.7. on page 26).

If the **double milk tube** is used, the frother does not need to be rinsed manually, because the **easyclean<sup>+</sup>** rinsing program rinses it automatically after the set time (see Chapter 7.1. on page 17) without having to remove the double milk tube from the milk source.

However, manual flushing is possible. Proceed as follows:

- Select and confirm the instruction with the *rotary dial* / by touching or
- In the **MAINTENANCE** menu, select the menu option **RINSE FROTHER**
- It is not necessary to remove the tube end from the connected milk source
- Put a sufficiently large container ( $\geq 0,5$  l) under the height-adjustable outlet and confirm with the rotary dial / by touching

The machine starts the rinse process. As soon as the rinse cycle is ended, the machine heats up and is then ready for operation again.

Even when the machine is switched off, the frother is automatically rinsed by **easyclean<sup>+</sup>** if the **double milk tube is used**.

- After switching off the machine, make sure to rinse the connection (valve) of the double milk tube under cold, clean water.

## 8.2. Clean frother

A message / instruction is shown on the display when the frother has to be cleaned.

- Select and confirm the instruction with the *rotary dial* / by touching or
- In the **MAINTENANCE** menu, select the menu option **CLEAN FROTHER**
- Put some detergent (recommendation: NIVONA CreamClean milk system cleaner) and water into a container (min. 0.3 l)
- Please observe the instructions of the detergent manufacturer for the mix ratio

- Follow the instructions on the display up to the end of the program and confirm each time with the *rotary dial* / by touching

The machine then heats up and is ready for operation again.

- Rinse the valve of the double milk tube under cold, clear water

### 8.3. Rinse system

The system should be rinsed from time to time.

- In the **MAINTENANCE** menu, select the menu option **RINSE SYSTEM**. The display shows **RINSING SYSTEM**

As soon as the rinse cycle is ended, the machine heats up and is then ready for operation again.

### 8.4. Clean system

- Put a sufficiently large container ( $\geq 0.5$  l) under the height-adjustable outlet
- Select and confirm the instruction with the *rotary dial* / by touching or
- In the **MAINTENANCE** menu, select the menu option **CLEAN SYSTEM**
- Follow the instructions on the display up to the end of the program and confirm each time with the *rotary dial* / by touching

The machine then heats up and is ready for operation again.

#### NOTE

A message / instruction is shown on the display when the machine has to be cleaned. Beverages can still be drawn. But we recommend carrying out the cleaning program as soon as possible to avoid endangering the warranty.



CONNECT TUBE TO  
THE OUTLET AND  
PUT IN CLEANER



CLEANING  
FROTHER



RINSE VALVE UNDER  
COLD WATER



#### CAUTION

The running program  
must not be interrupted!



RINSING  
SYSTEM



#### CAUTION

The running program must not be interrupted!

Please do not insert a cleaning tablet into the round opening of the brewing unit until the machine instructs you to do this.



CLEANING  
SYSTEM

**CAUTION**

Please always remove residual descaling fluid on the housing with a moist cloth afterwards!

**NOTE**

A message / instruction is shown on the display when the machine has to be descaled. (The descaling program can also be started manually at any time.) Beverages can still be drawn. But we recommend carrying out the descaling program as soon as possible to avoid endangering the warranty.



DESCALING  
SYSTEM

## 8.5. Descal system

**CAUTION**

**The running descaling program must not be interrupted!**

**Both the single milk tube and the double milk tube can be used for the descaling program.**

Never use vinegar or vinegar-based material for descaling, but always use commercially available **liquid products** recommended for fully automatic coffee machines (recommendation: NIVONA PREMIUM liquid descaler).

The filter (if present) must be removed from the water tank prior to the start of the descaling program.

**During descaling, please follow exactly the sequence of the displays!**

First fill in the corresponding amount of **water** up to the 0.7 l mark and **then** add the **descaler**. **Never in reverse order!** Observe the instructions of the descaler manufacturer.

- Select and confirm the instruction with the *rotary dial* / by touching or
- In the **MAINTENANCE** menu, select the menu option **DESCALE SYSTEM**
- Put a sufficiently large container ( $\geq 0.7$  l) under the height-adjustable outlet
- Follow the instructions on the display up to the end of the program and confirm each time with the *rotary dial* / by touching

The machine then heats up and is ready for operation again.



## 8.6. Remove & clean brewing unit

The brewing unit should be removed and cleaned under running water as needed. Please never use detergent, but only pure **cold** water!

- Open the service door on the right side of the housing (gently pull the unlocking device inside the handle forward, then carefully remove the service door from the housing)
- Unlock the brewing unit (press the red switch upward and turn the handle to the left up to the stop and to lock)
- Carefully remove the brewing unit with the handle
- Clean the brewing unit under cold, running water and **then let it dry**
- Carefully insert the brewing unit again and lock it (hold down the red switch and turn the handle to the right up to the stop and to lock it)
- Close the service door again (guide pins on the rear of the service door into the recesses, then press the service door until it locks in place)

### CAUTION

Clean the brewing unit at least once a month. Otherwise, warranty claims may be excluded.



Open / close the service door

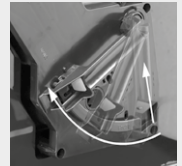

Unlock the brewing unit

**⚠ CAUTION**

Never immerse the machine in water!  
Do not use scouring agents for cleaning.  
Dried milk residue is hard to remove.  
Therefore, always clean immediately after the machine cools down! Always follow the message / instructions on the display on rinsing and cleaning the frother.

**⚠ CAUTION**

The connection (valve) of the double milk tube must be cleaned manually every day.  
To do this, remove the double milk tube from the machine and clean the valve under cold, clear water.



Double milk tube



Valve of the double milk tube



RINSE VALVE  
UNDER COLD  
WATER

**8.7. Clean regularly by hand****i NOTE**

Please follow these cleaning instructions. Maximum cleanliness is required, especially when handling food and beverages.

When cleaning the drip tray, make sure that the two metal contacts and the space between them at the rear of the drip tray are always clean and dry. Occasionally use some soapy water to clean the drip tray.

From time to time (ideally before every longer break in coffee making, but always on a regular basis!), the frother must be disassembled completely and then cleaned under cold, clean water.

The machine is equipped with rear rollers. These permit movement on a flat work surface. This allows cleaning under the machine.

- Clean the housing inside and outside only with a soft, moist cloth without detergent
- Empty the drip tray and coffee grounds container not later than when shown on the display (only with the machine switched on, as only then can it tell that the containers have been emptied)
- After the drip tray and coffee grounds container have been removed, clean the housing inside with a soft, moist cloth without detergent
- The water tank should be rinsed under clean water daily and refilled with fresh, cool water
- Clean the frother, tube, and outlet regularly

**TIP**

To clean the display during operation, the display can be locked in the **MAINTENANCE** menu under the item **SCREEN MAINTENANCE**. Pressing the *rotary dial* once releases the lock.

### 8.8. Disassemble and clean frother

- Remove the cover plate at the height-adjustable outlet, gently pull the frother down and then out to the front and take it apart
- Thoroughly clean the parts and put the frother back together
- Insert the assembled frother back in the height-adjustable outlet
- Reattach the cover plate to the height-adjustable outlet

### 8.9. Change filter

The filter's effectiveness is used up after about 50 l of water has flown through it. A message / instruction to replace the filter appears on the display.

- Select and confirm the instruction with the *rotary dial* / by touching or
- In the **SETTINGS** menu, select the **FILTER** menu option
- Select **YES** so that the machine detects that a filter is currently inserted
- Select **CHANGE FILTER**



Cover plate on the height-adjustable outlet



Assembled frother



Individual parts of the frother

#### **i** NOTE

You can continue to draw beverages. But we recommend changing the filter immediately.

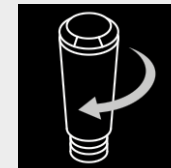

Screw the filter into water tank



Unscrew the filter from the water tank

**CAUTION**

Insert the filter **straight** and do not overturn!

**CAUTION**

In case of low water consumption, you must replace the filter not later than after two months. No message appears on the display. You can set the replacement date with the dial on the head of the filter (month indicator).

- Empty the water tank; carefully unscrew the old filter from its holder using the mounting aid at the end of the measuring spoon, and throw the filter away
- Carefully screw the new filter into its intended holder in the water tank using the mounting aid at the end of the measuring spoon
- Place a large container (> 0.5 l) under the outlet and confirm
- Wait for some time until no more water comes out of the outlet

The machine then heats up and is ready for operation again.

### 8.10. Status of maintenance

The machine shows through a progress bar whether cleaning or descaling will be required soon. The further to the right the progress bar is, the sooner the cleaning / descaling will be needed.

- In the **MAINTENANCE** menu, select the **STATUS OF MAINTENANCE** menu option

## 9. SOLVING PROBLEMS YOURSELF

The following table shows some causes and options for solving the problem if the machine does not work properly.

If the system detects a fault, an error message appears on the display:

- **Note the error message**  
(according to the table on page 30 / 31, error 8 can sometimes resolve itself)
- **Switch off the machine**
- **Pull out the mains plug**

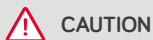

### CAUTION

If a fault occurs, or you cannot fix a problem yourself, please contact your selling dealer or visit the service area at [www.nivona.com](http://www.nivona.com).

The following information is important for fast, competent processing of the matter

- **Model** of the NIVONA product
- **Serial number**
- If available:  
**Error number / error message**

### Type plate (example)



**i NOTE**

To avoid problems, the following should be observed:

- Always remove the water tank from the machine to fill it
- Do not store coffee beans in the refrigerator
- Always empty containers with the machine switched on
- Use fresh and cooled milk

Problem	Cause	Remedy
No hot water or drawing of milk foam / steam possible	System might need descaling	Perform high-dosage descaling (Chapter 8.5.)
	Frother is plugged	Disassemble the frother completely and clean it thoroughly
Too little milk foam or liquid foam or milk splashes when frothing	Frother is plugged	Disassemble the frother completely and clean it thoroughly
	Unsuitable milk	Use cold milk
	System might need descaling	Perform high-dosage descaling (Chapter 8.5.)
	Valve of the double milk tube is plugged	Place the valve in liquid CreamClean milk system cleaner, let it soak in and then rinse thoroughly under clean water; reduce the time interval for automatic frother rinsing (Chapter 7.1.)
Coffee comes out only dropwise	System might need descaling	Perform high-dosage descaling (Chapter 8.5.)
	Grind fineness is too fine / too coarse	Set grind fineness coarser / finer (Chapter 7.2.)
	Ground coffee is too fine	Use coarser ground coffee
	Too much ground coffee added	Add less ground coffee

Problem	Cause	Remedy
Coffee comes out only dropwise	Brewing unit is plugged	Remove and clean the brewing unit (Chapter 8.6). Reinsert the brewing unit and perform system cleaning (Chapter 8.4).
	Coffee outlets are plugged	Perform system cleaning (Chapter 8.4.)
Coffee does not have "foam"	Brewing unit is plugged	Remove and clean the brewing unit (Chapter 8.6). Reinsert the brewing unit and perform system cleaning (Chapter 8.4.).
	Unsuitable coffee type	Change the coffee type
	Beans are no longer roast-fresh	Use fresh beans
Loud noise in the grinder	Grind fineness not adapted to coffee beans	Optimise the grind fineness (chapter 7.2.)
	Foreign matter in the grinder, e.g. small stones	Call the NIVONA service telephone; ground coffee can still be used
The display shows <b>Error 8 SERVICE PHONE</b>	The drive cannot properly position the brewing unit	Switch off the machine and pull the plug. Plug it back in and switch on the machine. If the machine is ready for operation, remove and clean the brewing unit (Chapter 8.6).
Despite emptied and inserted containers, the display shows <b>EMPTY TRAYS</b>	Gap between the contacts at the rear of the drip tray is dirty	Clean the gap between the contacts with water and some detergent as well as a brush, then dry



EVAPORATING



#### NOTE

Both the single milk tube and the double milk tube can be used for the cleaning program.



#### WARRANTY & CUSTOMER SERVICE CONDITIONS

Please see the accompanying information sheet for detailed warranty and customer service conditions.

## 10.

### 10. ACCESSORIES & COFFEE ASSORTMENT

Our current assortment of accessories and coffee can be found at [www.nivona.com](http://www.nivona.com).

## 11.

### 11. CUSTOMER SERVICE & WARRANTY

If you have to send in the machine due to a defect, first evaporate it out so that no water remains in the system.

#### How to make your machine ready for shipment | Evaporate machine

- In the **MAINTENANCE** menu select the **EVAPORATE SYSTEM** menu option
- Follow the instructions on the display until the end of the program and confirm each time with **NEXT**
- Empty drip tray, coffee grounds container, water tank and ideally the coffee bean holder
- Reinsert all parts
- Pack the machine, ideally in the original packaging (no liability can be accepted for transportation damage)

## 12.

### 12. PACKAGING & DISPOSAL

The machine's complete original packaging should be kept to protect it during shipping in case customer service is needed.

Electrical and electronic appliances contain many materials which are still valuable or are harmful to the environment, and these should not be treated in the same way as normal household waste. If treated as household waste or handled incorrectly, they may cause harm to human health or the environment. Therefore, never throw a defective machine away with



household waste, but bring it to the community collection point for return and recycling of old electrical and electronic devices.

You can obtain more information from your local town hall, waste disposal service provider, or the retailer from whom the machine was purchased.

Filter cartridges are disposed of as household waste.

### 13. TECHNICAL DATA

Voltage	220–240 V AC, 50–60 Hz
Power output	2400–2800 W
Conformity mark	CE
Static pump pressure max.	15 bar
Water tank capacity	approx. 3.5 l
Coffee bean holder capacity	approx. 600 g
Coffee grounds container capacity	approx. 22–37 portions*
Cable length	approx. 1.6 m
Weight	approx. 13.4 kg
Dimensions (W x H x D)	approx. 30 x 42 x 48 cm
Bluetooth**	Frequency range: 2,400–2,483.5 MHz Max. transmission output: 10 mW

\* Depending on the coffee strength used

\*\* NIVONA Apparate GmbH hereby declares that the radio system complies with the Directive 2014/53/EU. The complete text of the EU conformity declaration is available at the internet address [www.nivona.com](http://www.nivona.com) in the SERVICE download area.





**NIVONA**

**NIVONA** Apparate GmbH

Südwestpark 49  
D-90449 Nürnberg  
[www.nivona.com](http://www.nivona.com)

2023 © Copyright NIVONA Apparate GmbH, Germany  
All rights reserved

ANR 000129888  
BDA NICR 1040 GB Rev.02 27.02.2023